

Preventative Maintenance Xcite™ Airmix®

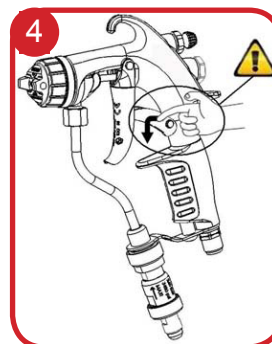

DO THIS BEFORE ANY MAINTENANCE ACTION:

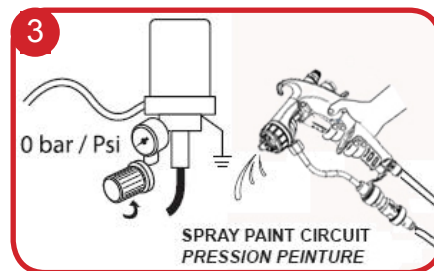
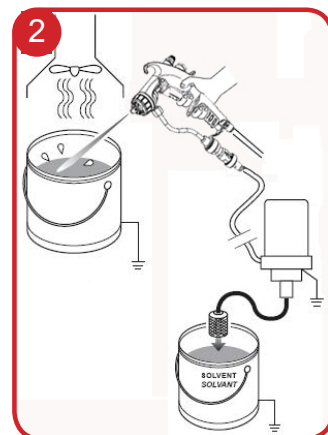

DAILY MAINTENANCE:

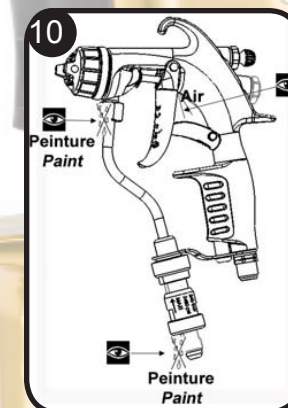
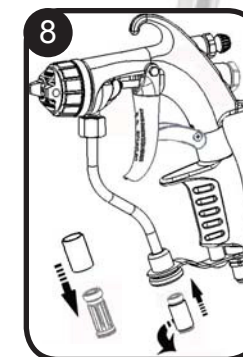
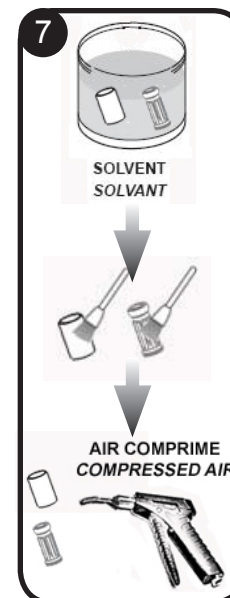
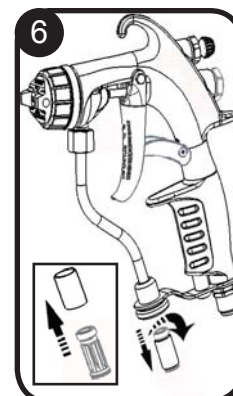
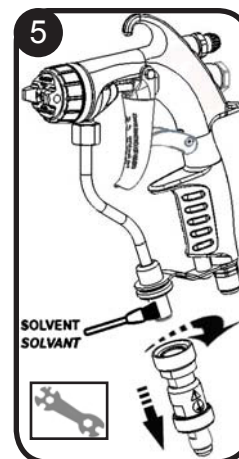
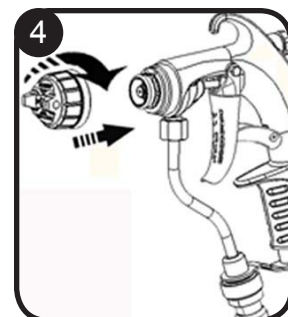
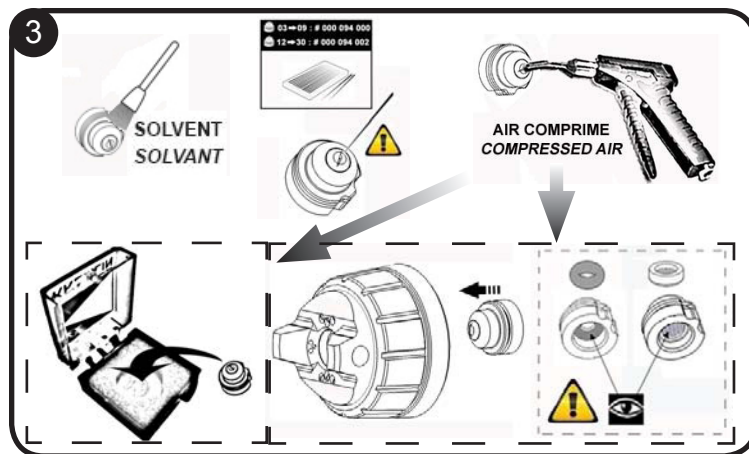
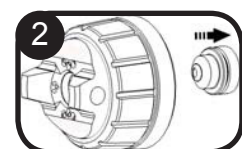
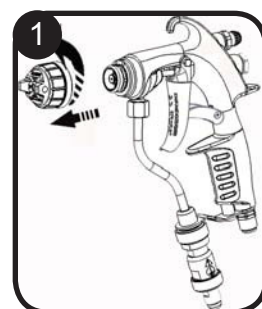

WEEKLY MAINTENANCE:

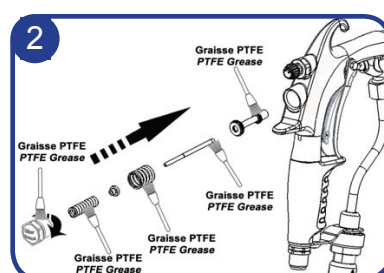
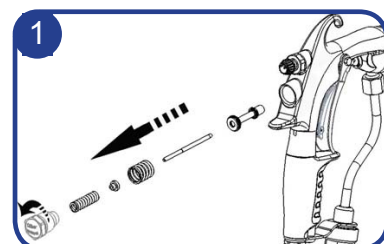

QUARTERLY MAINTENANCE:

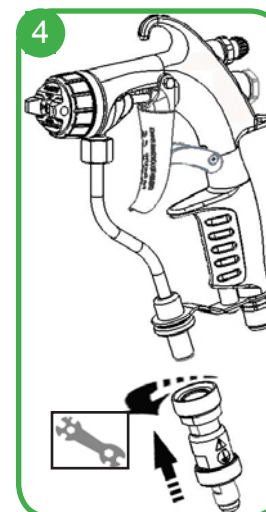
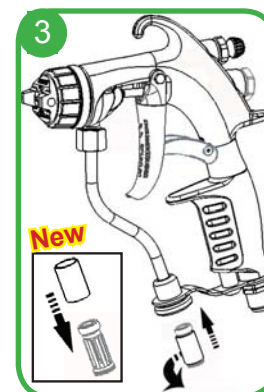
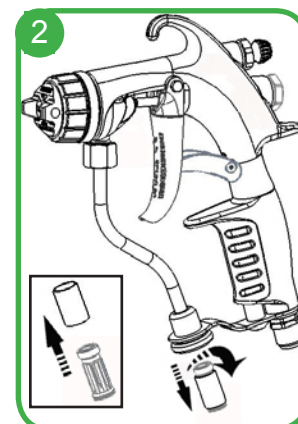
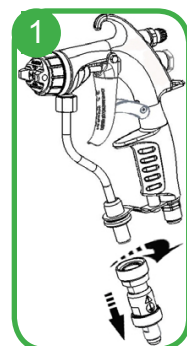

YEARLY MAINTENANCE:

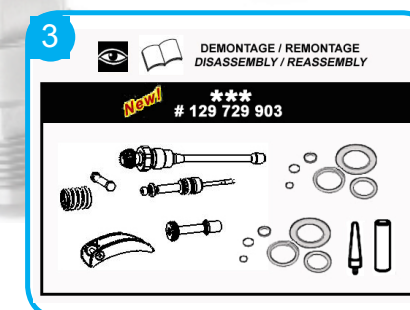
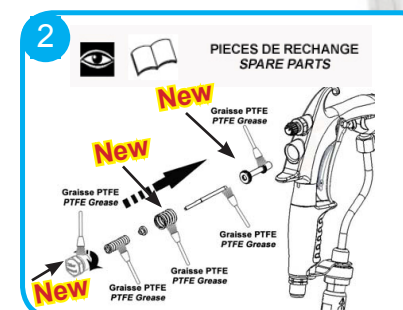
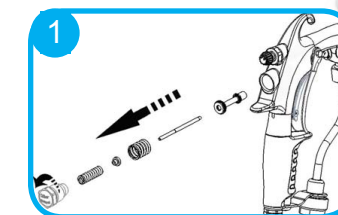

=CRITICAL STEP